

수요 수량	품번	품명	재질	규격	비고
G03 G02 G01	ITEM	DESCRIPTION Out Line	MATERIAL	SPECIFICATION FB Series	REMARK Brake Type

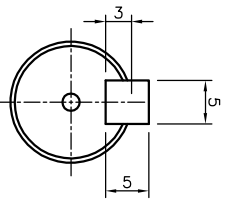

<축단 상비드 S/C 2:1>

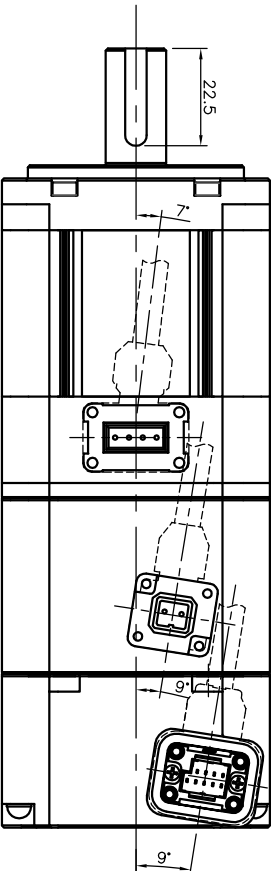

<외형 치수>

No.	Model	L	LM	LC
G01	XML-FB01ANK2	149.2	119.2	43
G02	XML-FB02ANK2	160.2	130.2	54
G03	XML-FB04ANK2	180.2	150.2	74

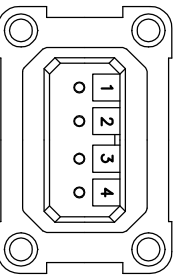
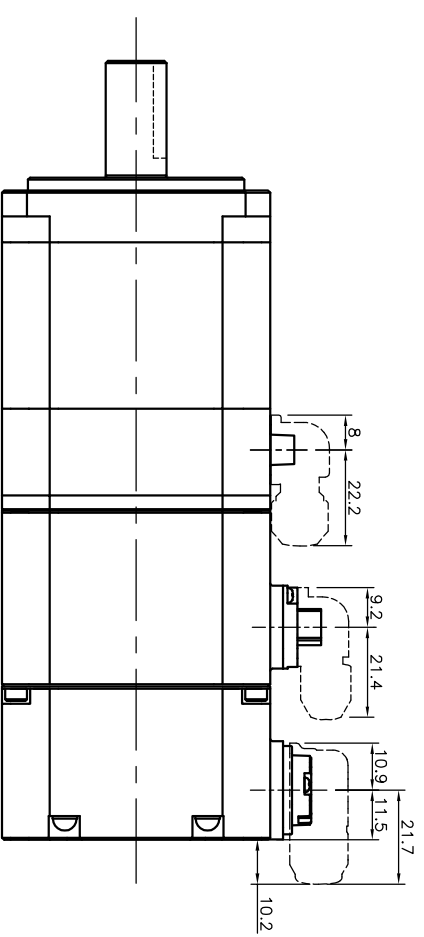
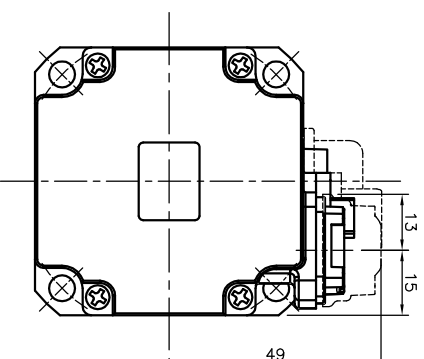
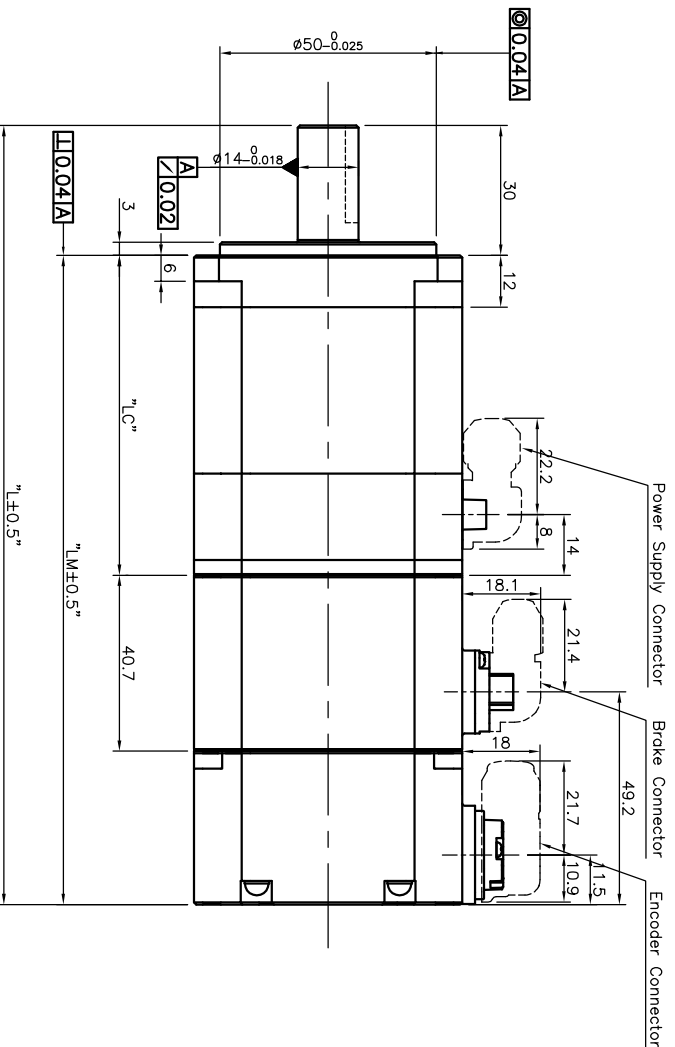
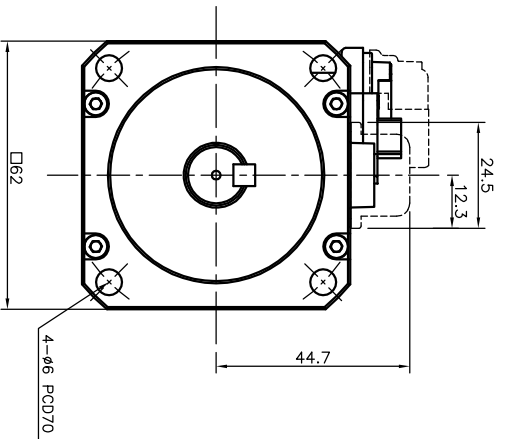

<전원용 Connector 핀 배열>

핀번호	신호명
1	W
2	V
3	U
4	접지선

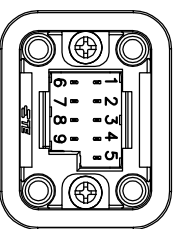

<Encoder Connector 핀 배열>

Single Turn (N)		신호명	신호명	신호명
1	MA	MA	백색	백색
2	SLO	SLO	노란색	노란색
3	-	-	노란색	노란색
4	OV	OV	노란색	노란색
5	SHIELD	SHIELD	FG	FG
6	MA	MA	노란색	노란색
7	SLO	SLO	노란색	노란색
8	-	-	노란색	노란색
9	+5V	+5V	노란색	노란색

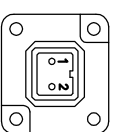

<Brake Connector 핀 배열>

핀번호	신호명
1	B1
2	B2

내수용			수출용			Encoder Type
제품명	Code	제품명	Code	제품명	Code	Encoder Type
XML-FB01ANK2	47160094	XML-FB01ANK2E	4716009400	XML-FB01ANK2E	4716009400	Serial 19Bit -Single Turn
XML-FB02ANK2	47160095	XML-FB02ANK2E	4716009500	XML-FB02ANK2E	4716009500	
XML-FB04ANK2	47160096	XML-FB04ANK2E	4716009600	XML-FB04ANK2E	4716009600	

XGT Servo Motor



XML-FB01ANK2의 2종

매 수 SHEETS

각도 3RD ANGLE PROJECTION	척도 SCALE	단위 DIMENSION	작성일 DATE	도면명칭 TITLE	도면번호 DWG. NO.	1/1
NS	MM	2012.09.12.	XGT Servo Motor	47160094의 2종		

CHANGE

개

정

체도 DRAWN	설계 DESIGNED	검도 CHECKED	승인 APPROVED	관련도면 REF. NO.
-------------	----------------	---------------	----------------	------------------